

**KANSAS WESTERN
HORSEMAN'S
ASSOCIATION, INC.**



**CONSTITUTION & BY-LAWS
RULES & REGULATIONS**

2021-2022

2021 OFFICERS

PRESIDENT

Ross Clouston Meriden

VICE PRESIDENT

Willard Sanders Scott City

SECRETARY

Linda Sanders Scott City

TREASURER

Norleen Knoll Hays

POINTS RECORDER

Tammy Clouston Meriden

ADVISOR

BOARD OF DIRECTORS

Cameryn Kinderknecht Ellis

Diane Kuhn Ellis

Renee Nichols Walker

Robert Potter Halstead

Linda Sanders Scott City

Heather Vanover Hope

Troy Cooley Alton

Kelly Forell Victoria

Audrey Henderson Sedgwick

Jeff Henderson Sedgwick

Cheyenne Newberg Hutchinson

Chloe Wilson Wellington

(Jr) Doak Guttery Alton

(Jr) Kaylee Henderson Sedgwick

TABLE OF CONTENTS

	PAGE
Chapter I – Constitution	
I. Name	3
II. Objective	3
III. Membership	3
IV. Representation	3
V. Officers & Directors	4
VI. Executive Committee	4
VII. Meetings	5
Chapter II – By Laws	
I. Dues	5
II. Fiscal Year	5
III. Officers	5
IV. Elections	8
V. Vacancies	9
VI. Quorum	9
VII. Compensation	10
VIII. Procedure	10
IX. Liabilities	10
X. Amendments	10
XI. Shows	11
XII. Committees	11
Chapter III - Rules & Regulations for Kansas Shows	11
Chapter IV - Rules Governing Judged Events	17
1. Reining	20
2. Western Pleasure	27
3. Junior Horsemanship	27
4. Queen Contest	27
5. Western Lead Line	28
6. Bareback Tandem	28
7. Bareback Horsemanship	29
8. Walk Trot Horsemanship	29
Chapter V - Rules Governing Races	
1. General Rules	29
2. Events	31
A. 360 Eight Race	32
B. Balloon Race	32

C	Barrel & Stake Race	32
D	Barrel & Stake Graduated	33
E	Cloverleaf	33
F	Cowhide	33
G	Devil's Cowhide	33
H	Figure 8 Stake Race	34
I	Flag Race	34
J	Flying W Race	34
K	Half 8 Race	34
L	Hay Race	34
M	Keg Bending Race	34
N	Key Race	35
O	Lead Back Race	35
P	Musical Chairs	35
Q	Pair Race	36
R	Pair Sack Race	36
S	Pole Bending Race	37
T	Polo Turn	38
U	Pony Express Race	38
V	Relay Race	38
W	Rescue Race	39
X	Ribbon Race	39
Y	Rock & Roll Race	39
Z	Saddling Race	40
AA	Saddle & Rescue Race	40
BB	Speed Barrels	41
CC	Stock Horse Race	41
DD	Straight Barrels	42
EE	Trailer Race	42
FF	Tunnel Race	42
GG	Two Barrel Flag Race	42
HH	Water Carry Race	42
II	Western Relay Race	42

Chapter VI – Miscellaneous Rules

1.	Judges	43
2.	Judging	44
3.	Protests	44
4.	Penalties	44
5.	Points System	45
6.	Ratings	45
7.	Regulations for KWHA State Shows	46

CHAPTER I – CONSTITUTION

Article I. Name

Section I. The name of this association shall be Kansas Western Horseman's Association, Inc.

Article II. Objectives

Section I. To promote and assist the riding clubs of Kansas in the care, use, handling and development of the Western horse.

Section II. To encourage good sportsmanship and proper conduct among horsemen and horsewomen and to foster good will and cooperation among the riding clubs of Kansas.

Section III. To hold a fall show of winners from the various local events held by member clubs approved by this Association and encourage classes for Western horses. This Fall Show must be sponsored by a Member Club.

Section IV. This Association shall own and hold the exclusive rights to produce their Annual Fall Show.

Section V. This Association shall be a non-profit organization and shall not be operated for pecuniary profit and there shall be no capital stock.

Article III. Membership

Section I. Any active, organized riding club using western equipment and interested in the aims of this association shall be eligible to membership in the association upon payment of the membership fee as fixed by this association, providing they have been sponsored by a member club and elected by a majority vote of the Board of Directors.

Article IV. Representation

Section I. Each member club in good standing shall be allowed two voting delegates, regardless of the number of their members and these delegates shall constitute the voting body of the association. To be considered a club in good standing the following criteria must be met:

1. Annual club dues must be paid by April 1st of each year to the KWHHA State Secretary.
2. Must hold one KWHHA sanctioned show annually. In the event that the scheduled show is not held due to

inclement weather or arena conditions this will not be held against the member club.

3. If the member club has riders participating the KWHHA State Horse Show the club will participate in working one event during the KWHHA State Show Committee and may be joined with another member club in order to work the state show event.

Article V. Officers and Directors

Section I. Officers of the Kansas Western Horseman's Association shall be:

President, Vice-President, Treasurer, and a Board of Directors including Jr. Representatives. The outgoing President shall serve one year as Advisor to the President, after serving his/her full term.

Section II. The Officers and the Board of Directors, including Jr. Representatives, shall be selected from the membership at large. The officers shall hold office for a period of one year and the members of the Board of Directors shall hold office for a period of two years, except as provided during the first of this association, when directors may be elected to hold office for a period of three years.

Article VI. Executive Committee

Section I. The executive committee of this association shall consist of a President, Secretary, and three members who shall be elected from the Board of Directors. The executive committee shall, in the absence of specified direction from the Board of Directors or the voting body, have the sole power to authorize the execution of any contract on behalf of the association or authorize the expenditure of any of its funds.

Section II. Only one (1) family member may serve on the Executive Committee at any one time. Family member shall be defined as: husband, wife, son, daughter, mother, father, grandfather, grandmother, grandson, granddaughter, brother, sister, nephew, niece, aunt, uncle, and stepfamily members or in-laws as noted here.

Article VII Meetings

Section I. Meetings of this association, except the annual meetings, shall be held at such times and places as set up by the Board of Directors. The Board of Directors, at first official meeting of new board, shall also set the annual meeting.

CHAPTER II – BYLAWS

Article I. Dues

Section I. The dues for each member club shall be thirty (\$30.00) per year, payable in advance to the Secretary. The dues thereafter shall be fixed by a majority vote of the delegates present at the Annual Meeting. The Secretary shall notify member clubs whose dues are not paid by the first of March and those whose dues are not paid by the first of April shall be dropped from the membership roll. Member Clubs dropped for non-payment of dues may reinstate at any time by the payment of the current year's dues. Member clubs that pay their dues after the first of April will not be allocated the two voting delegates at the Annual Meeting that fiscal year.

Article II. Fiscal Year

Section I. The fiscal year of this association shall be from the first of December to the first of December the following year. Officers and directors elected at the annual meeting shall take office the first of December and serve till the first of December the following year.

Article III. Officers

Section I. The President shall be the chief executive officer of the association. He shall preside at all regular and special meetings of members and the Board of Directors; he shall have active and general management of the association; he shall see that orders of the voting body and the Board of Directors are carried into effect; he shall execute or cause to be executed any contracts of the association as authorized by the executive committee; he shall appoint all committees unless otherwise provided and he shall be an ex-Officio member of such committees.

Section II. The Vice-President shall act for the President in

the absence of that officer, and in case of a vacancy in the office of president, he shall fill said office until next regular election.

Section III. The President, with the approval of the Board of Directors, shall appoint the Secretary. The Secretary shall keep an accurate record of the proceedings of all meetings of the membership of the Board of Directors in a book provided by the association for the purpose and shall keep accurate record of dues and turn to same to Treasurer at 30 day intervals and shall perform like duties for committee meetings when so required. He shall be an ex-Officio member of all meetings, regular or special, to the members and Board of Directors and shall perform such other duties as prescribed by the President or Board of Directors.

Section IV. The Treasurer shall keep a full and accurate account of all receipts and disbursements of the association in a book provided by the association for that purpose and shall deposit all moneys of the association and other valuable effects in the name and to the credit of the association in such depository as designated by the Board of Directors. He shall disburse the funds of the association upon order if the executive committee on a voucher properly signed by the President. He shall render to the association at any regular or special meeting if required, a complete account of his transactions as Treasurer and of the financial conditions of the association. He shall furnish bond, to be paid for by the association, in the sum and with sureties as may be satisfactory to the Board of Directors, for faithful performance of his duties and the restoration or removal from office, all books, papers, vouchers, money or other property belonging to the association.

Section V. The Board of Directors shall consist of Vice-President, the Advisor, Treasurer, two Jr. Representatives (14-18) and twelve members elected by the voting body, and two Jr Representatives (aged 14-18 with no voting rights) to be chosen from the various communities of the State to the end, that the Board may be representatives of the State as a whole. The Board of Directors who shall meet as often as deemed necessary shall manage the business, activities and property of the association. Meetings other than the annual

meeting may be called at any time by the President, executive committee, or on written request of a majority of the Board of Directors. Due to death or resignation of both President and Vice-President the Board of Directors may elect a new President out of the existing Board of Directors.

Section VI. The President, with approval of the Board of Directors, shall appoint the Points Recorder.

The responsibilities of the Points Recorder are as follows:

- Keep all entry forms and records until approval of the Board of Directors to dispose of them.
- Contact the contestant immediately if an entry form cannot be recorded, after approval by Board or Executive Committee.
- Make sure contestants are qualified for any events they enter at State Show.
- Total State Show entry fees for each club. Be sure the check from the saddle club is the correct amount. Contact club secretary immediately if it is not.
- Points Recorder and one other person from points committee will figure points for State Show.
- Points Recorder will act as Secretary at the State Show.
- Get numbers for judged events and assign for the State Show. Distribute numbers to individual Saddle Club Secretaries or representatives.
- Create State Show Program. Points Recorder may have an assistant with this duty.
- Points Recorder and points chair will audit points halfway through the season and do a second audit after the last show of the season.
- An event must be held in 5 shows during the year to receive a year-end individual event certificate.
- Print awards for Year-End Awards Banquet. This includes certificates for high point overall and Saddle Clubs. (Include points and placing for each event and total points.)
- Contact club secretaries to let them know who in their club is receiving awards. The Secretaries should then contact the individual contestants.

Section VII. The President, with the approval of the Board

of Directors, shall appoint the Historian. The responsibilities of the Historian are as follows:

- Keep all Historical data of the KWHHA organization.
- Maintain records and revision history of all KWHHA forms or documents that require changes.
- Any other additional duties as required by the KWHHA President and BOD.

Article IV. Elections

Section I. The election of officers and directors shall be held at the annual meeting. The Nominating committee, to be appointed by the President and consisting of at least three members from different localities, shall place in nomination candidates to fill existing vacancies. Other nominations may be made from the floor.

Section II. Voting shall be by secret ballot.

Section III. Members of the Board of Directors are elected as follows; at the regular meeting six directors are elected for a term of three years and six for a term of two years and two Jr. Representatives for a term of one year. Beginning with the second annual meeting the existing vacancies shall be filled by the election of six directors for a term of two years.

Article V. Vacancies

Section I. If an officer or director of this association dies, resigns, is disqualified, or otherwise cannot perform the duties of his office, the remaining directors may elect a successor to his office from the delegates who shall hold office during the remaining term and until his successor is elected at the annual meeting; except, the office of President which shall be filled by the Vice-President for the remaining term. In the event of the death or resignation of both the President and Vice-President, the Board of Directors may elect a new President out of the existing Board of Directors.

Section II. Any officer or director may resign his office at any time, providing the resignation is presented in writing and to take effect immediately upon its receipt by the association unless a time is fixed in the resignation. The acceptance of the resignation is not necessary to make it effective.

Section III. Any officer or director may be removed from office by a two-thirds vote of the entire membership of the Board of Directors, providing the charges against such officer have been presented in writing at least thirty days prior to balloting.

Article VI. Quorum

Section I. The delegates present at the annual or any regular meeting shall constitute a quorum for the transaction of business, providing notices have been mailed to all member clubs at least five days previous to the meeting.

Section II. Five or more members of the Board of Directors shall constitute a quorum for the transaction of business and the act of the majority of the members present, being five or more, at board meetings shall be the act of the Board of Directors unless the act of a greater number is required by-law or by the by-laws. The Board of Directors shall be mailed a notice of the meeting and its purpose at least five days previous to the meeting.

Section III. The majority of the executive committee shall constitute a quorum for the transaction of business. A notice of the meeting and its purpose must be mailed to committee members at least five days prior to such meeting.

Article VII. Compensation

Section I. Officers as such, shall not receive compensation for their services, but by resolution of the Board of Directors may be reimbursed for any actual expense incurred by reason of their office.

Section II. Directors of the association as such, shall not receive compensation for their services, but by resolution of the Board of Directors may be reimbursed for any actual necessary expense incurred by reason of their directorship.

Article VIII. Procedure

Section I. At the meetings of the association the suggested order of business shall be: a) reading of the minutes b) report of the Board of Directors c) report of committees d) unfinished business e) new business.

Article IX. Liabilities

Section I. The Executive committee or Board of Directors

shall not have the power to subject the Association to an indebtedness exceeding the current funds at the time in the treasurer, nor shall it have the power to levy special assessments against its Member Clubs and the Member Clubs of the association shall not be liable for any debts of the association.

Article X. Amendments

Section I. The constitution of this association may be amended at any regular or special meeting of the voting body by two-thirds majority of the delegates present, providing the proposed amendment has been read at a previous meeting or copies have been sent to all member clubs at least thirty days prior to balloting.

Section II. The by-laws of this association may be amended at any regular or special meeting of the voting body by a majority vote of the delegate present, providing the proposed amendment has been read at a previous meeting or copies have been sent to all member clubs at least thirty days prior to balloting.

Article XI. Shows

Section I. Entries in the Fall Show of this association shall be governed by the rules and regulations of this association as approved by the voting body of this association for all contests.

Section II. The Board of Directors shall make the final decision on any question arising from such rules and regulations by a majority vote.

Article XII. Committees

Section I. Such committees as the President and Executive Committee may deem essential to carry out the business of the association shall be appointed as here-in-before provided. The chairman and members of such committees shall be chosen from the delegates or members of any Member Club in good standing.

CHAPTER III – HORSE SHOW RULES AND REGULATIONS FOR KANSAS SHOWS

A. In order for the KWHHA to make yearly western horse ratings, a uniform set of rules and regulations must be used in all horse shows in the State of Kansas and the following rules and regulations are applicable to all horse shows sanctioned by KWHHA

B. The rules and regulations of the KWHHA will be recommended by the rules committee and adopted by the Board of Directors after the voting body of this association at their annual meeting has acted on all proposed changes. In order to receive the benefits of the yearly Western Horse rating, the general rules and regulations for Kansas Shows as adopted by the Board of Directors and the voting body of this association and as proposed by the rules and regulations committee must be followed. All horse shows held in the State of Kansas will be bound and governed by the following horse show rules without exception.

C. Proposed changes in the rules and regulations of the KWHHA must be submitted to the Board of Directors and in the hands of the Rules Committee via e-mail, hand delivered, or postmarked on or before August 1st of even numbered years in order for them to be considered. A copy of the proposed rules changes will be sent to each Saddle Club via e-mail or US Mail at least 30 days before the annual meeting. Rule changes must be voted on at the annual meeting as written.

D. Proposed changes will be submitted at the annual meeting and voted on by Club Delegates.

E. To compete in the KWHHA State Show, a contestant must have accumulated a total of a minimum of 4 points as a unit of rider, horse, and saddle club from member shows throughout the year for each event entered. These entries will be made on valid KWHHA entry forms and sent along with a check to the Points Recorder by the Saddle Club Secretary.

F. The management reserves the right to reject the entry of any contestant who has violated the general rules, who has been dishonest in competition, or who has proven to be

undesirable in any recognized member show event.

G. The managers assume no responsibility or liability for injury or damage to the person, property, or stock of any owner, contestant, or assistant. Each participant by the act of his entry waives all claims against the management for injuries he or his property may sustain.

H. In all timed events, the contestant's time will be announced as soon as it is received from the official timer. Official timekeepers shall keep a record of times recorded for contestants. Any contestant questioning his announced time in any event must make complaint at the announcing stand before the close of the day's show.

I. Contestants must be on hand to answer call of arena director and must comply with all other rules of the management of each particular contest or exhibition. When, in the opinion of the arena director, sufficient number of contestants is present for an event, there will be no delay because others are not present.

J. The management may withdraw any contestant's name and entry, debar him from any or all events and withhold any money due him for violation of any of the governing rules or rule of the judges, for any of the following offenses:

- Being under the influence of liquor;
- Being rowdy;
- Mistreatment of stock;
- Causing altercations or quarreling with judges or officials.

K. Contestant is privileged, if he so desires, to see the record of all contestants in any event in which he takes part, at the end of each go-around, provided that said requests be made at a time convenient to the clerk when the records are available.

L. All entry fees and/or office charge must be paid in advance.

M. All contestants should read the rules carefully, particularly those relating to the contest or events in which they enter. Failure to understand rules will not be accepted as an excuse.

N. Every member show shall appoint a ring committee that

shall be present at, and responsible for, the enforcement of the rules, and shall operate under the authority of the Rules Committee and all controversial matters shall be referred to the Rules Committee, whose decision shall be final.

O. Each member show shall be required to furnish the Points Recorder of the KWHHA a record in the form of the top four placing contestant's entry forms showing the top four individual places in each event according to the decision of the judge. A copy of the show bill plus a listing of those classes that were not full classes and how many entries those classes had should be sent also. This report must be signed by the Recording Secretary of the show, the Horse Show Manager, Judges or other authorized local horse show officials, and shall be forwarded within 15 days after the closing date of the show. Failure to comply with this rule may result in omission of the show results from the tabulations of winning horses.

P. All horses shall be serviceably sound for the intended purpose.

Q. There shall be no substitute of riders or horses after class has started.

R. Post entries may be refused at the discretion of the local Horse Show Management.

S. It shall be the responsibility of the exhibitor to enter his horse only in the classes in which they are eligible.

T. Rules shall be carefully studied prior to the show by both Judge and contestants. Judges shall be provided with a scorecard listing contestant's number only. Riders shall show horses as their number is called. Winners shall be announced upon receiving awards. All KWHHA shows shall consist of only events listed in the official rulebook.

U. When a horse is used in consecutive judged events, all tack changes must be made at the arena gate.

V. Horse may be shown in more than one class or event.

W. It is suggested that each club specify on show bulletins that contestants must be members of clubs belonging to KWHHA.

X. The following race events; Cloverleaf Race, Pair Sack Race, Pair Race, Key Race, Pole Bending Race, Western Relay Race, Two Barrel Flag Race, Figure Eight Stake Race,

and Barrel and Stake Race will be timed only events.

Y. Class designations for contestants ages 18 and over shall be: Women (age 18-49), Senior Women (age 50 and over), Men (age 18-49), and Senior Men (age 50 and over). All contestants of these class designations must ride in their own age group.

Z. The age groups of all contestants, Junior or Adult class, will be determined by their age as of January 1st of the present year.

AA. The Juniors will be divided into the following age groups: 1 to 9 inclusive; 10 to 13 inclusive; 14 to 17 inclusive. In the following events: Junior Reining, Junior Queen, Junior Hay Race, Junior Bareback Horsemanship, Junior 220 and 440 races, the age groups shall be 17 years and under.

BB. Any horse having a tail set or synthetic tail attachment shall be disqualified from any judged event.

CC. All age groups shall be governed by the same set of rules.

DD. Numerous classes for juniors are urged and will be recognized by the Association.

EE. A junior must ride in his/her own age group where individual events are concerned. A junior cannot ride or be in command of a stallion in any race or judged event.

FF. When a barrel is used in a race event, it shall be a 55-gallon metal or plastic barrel except when otherwise specified.

GG. At any horse show sanctioned by the KWAHA Inc., all individuals entering will be assessed a \$3.00 office charge (\$2.00 to KWAHA and \$1.00 to KWAHA Scholarship Fund) which will be sent to the KWAHA Treasurer within 15 days with the name of show and the show date included. The club hosting the show, at their discretion, may access an additional \$1.00 to \$5.00 per contestant, per show, office charge, which the club will retain. The host club may have, at their discretion, entry fees per contestant, per event.

All fees that will be charged to competitors or spectators, including but not limited to office charges, entry fees, stall or arena charges must be published on the approved show bill.

Fees for the state show to be determined by the state show committee.

HH. Any person or his horse shall not compete in a KWHH Horse Show in such a way as to make it possible for either to win more than one placing in any one event.

II. For the State Secretary to approve the show bill for a saddle club to have a qualified show, it must have at least three events for each of the following age groups: 1-9, 10-13, 14-17, Women, Senior Women, Men and Senior Men. If any part of the show has to be canceled due to emergencies or weather, any events that have been completed before the cancelation will have the placings and points counted toward qualifying for state show and high point awards and the show will be classified as a qualified KWHH show.

JJ. For a club to have a qualified KWHH sanctioned show, the Show Date, completed Show Bill, and any applicable publishing fees set yearly by the Board of Director, must be submitted via e-mail, website submission, hand delivered, or postmarked to the KWHH Secretary at least 30 days before the date of the show to be approved. The Show Bill must list all contestant or spectator charges, approved KWHH Judge's name, and at least two names and phone numbers to contact for information. The KWHH Secretary and the Points Recorder must be notified if the show is cancelled. If both the Show Date and the Rain Date are cancelled, the show may automatically be rescheduled through the KWHH Secretary if each member club is notified at least one week before the scheduled date.

KK. The Board of Directors shall establish the show season for the current year.

LL. Contestants, while in the arena, may not have in their possession hot shots or other electrical devices designed as punishment or training aid for their horses.

MM. Team events are not to be restrictive as to age groups.

NN. If a KWHH member club, which is having an approved show, has reason to believe that their arena has become unsafe due to rain, storm damage, etc., they can, with the consent of a nearby club use their arena to have their show. If a show is to be moved from one club grounds to another, the club must either post a sign at their arena stating exactly

where the show has been moved or have a club member there to give directions to the new location.

OO. In all timed events if manual timers are used, the same person shall time all contestants in an age group or class.

PP. There shall be no one in any age group tied or fastened in the saddle in any way.

QQ. In all judged events contestants must wear western hat or protective headgear, cowboy boots, long sleeve shirt, jeans or pants. In all timed or race events contestants must wear cowboy boots or heeled-western equestrian sports shoes, jeans or pants, short or long-sleeved shirts, t-shirts or tank tops. No tube tops or sports bras permitted while running an event. Chaps and spurs are optional.

RR. In the event of rule changes being added or deleted at the Annual Meeting, it will be the responsibility of the Rules Committee to change the numbering system to keep all rules in sequence order when printing the new Rule Books.

SS. There shall be no KWAH shows held on the same date as the KWAH Benefit Show or KWAH Trail Ride unless it falls on the rain date.

CHAPTER IV – RULES GOVERNING JUDGED EVENTS

The Divisions listed below shall be shown as designated:

A. Western attire is required in order to receive a placing for the class in judged events. Western attire includes western hat or protective headgear, long sleeved shirt, pants or jeans, and cowboy boots. The hat must be on the rider's head when the exhibitor enters the arena (judge may overrule wearing of hats due to inclement weather). Use of gloves, ties, spurs, chaps, vest or coats is optional.

B. Junior horses will be classified as any horse 5-years old or younger. The age of the horse will be determined by January 1st of the year foaled. Reins may be held with two hands when riding a junior horse only when using a non-curb action snaffle bit with a broken mouthpiece (example conventional O-ring, D-ring or Egg-butt snaffles) or bosals. (No shanks of any kind may be used on a junior horse when

riding with two hands) Mecate reins may be used with snaffle bits and bosals only.

C. Equipment consistent with judged rules and bridles with covered nosebands will be permitted. Chain curbs are permissible but must meet the approval of the judge and must be at least one-half (1/2) inch in width, lying flat against the jaw of the horse. No tie down, martingale, cavesson noseband, or roping reins may be used. Spurs may be worn but must not be used unnecessarily.

Equipment

1. When rule book refers to snaffle bit, it means a snaffle bit with broken mouthpiece (Example conventional O-ring, egg-butt or D-ring)

A. Loose curb (chin) strap is permitted.

B. Reins to be attached above curb (chin) strap

2. No solid iron will be permitted under jaw regardless of how covered or padded.

3. Whenever this rule book refers to a curb bit in regard to a judged event, it means the use of a bit that has a solid or broken mouthpiece, has shanks and acts with curb (chin) strap action.

4. Horse will be shown in Western saddle (except in Bareback classes)

5. Silver equipment will not count over a good working outfit.

6. Chain curbs are permissible, but must meet the approval of the judge, must be at least one-half inch in width, and must lie flat against the jaw of the horse.

(As illustrated by photographs)

7. Equipment that will cause a horse & rider major deduction.

A. Wire curbs regardless of how padded or covered.

B. Martingales, tie-downs, cavesson.

C. Roping reins.

D. Any horse having a tail set or synthetic tail attachment shall be disqualified from any judged event.

Illustrations

Snaffle: Non-Leverage (no shanks)



O-Ring Snaffle

D-Ring Snaffle

Egg Butt Snaffle

Curb Bit: Leverage bit because of the action of the curb chain.

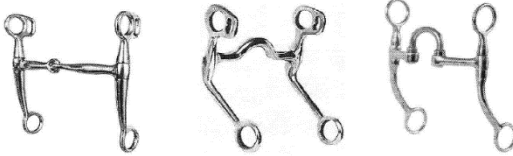

Tom Thumb

Grazing Bit

Correction Bit

Illustrations (Cont.)

Gag Bit: Sliding Action

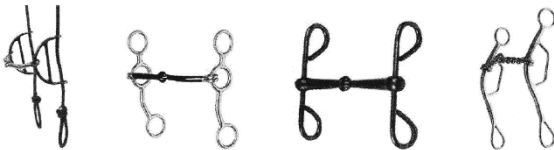

Gag Draw

Gag Bit

Draw Gag

Gag Bit

Mechanical Hackamore: Leverage bit with shanks and noseband.

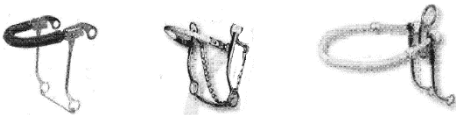

Hackamore/Bosal: Does not work off leverage. Consists of hanger (headstall), mecate or reins, and bosal.



Twisted Link Curb Chain-links lay flat



Double Curb Chain with link that lay flat



Straight Leather Curb Strap

Section I. Reining Class

A. All contestants concerned will gather at the arena at the proper time. Upon call each contestant will perform the required pattern individually and separately.

B. The arena or plot shall be approximately 50 x 150 feet in size.

C. Each horse will be judged on the neatness, dispatch, ease, calmness and speed with which it performs the pattern. Excessive jawing, open mouth or head raising on stop, lack of smooth sliding stop on haunches, breaking gaits, refusing to change leads, anticipating signals, stumbling or falling, wringing tail, backing sideways, knocking over kegs, changing hands on reins, or losing stirrup or holding on, or two hands on reins (except if contestant is riding a junior horse, see Rules Governing Judged Events) or any unnecessary aid given by the rider to the horse (such as unnecessary talking, petting, spurring, using quirt, jerking on reins, etc.) to induce the horse to perform will be considered a fault and scored accordingly. Horse shall rein and handle easily, fluently, effortlessly and with reasonable speed throughout the pattern.

D. Scoring will be on the basis of 60-80 with 70 denoting an average performance.

E. In case of doubt, a judge may require any contestant to repeat his performance of any or all the various parts of the pattern. A judge also shall have the authority to require the removal or alteration of any piece of equipment or accouterment, which, in his opinion, would tend to give a horse an unfair advantage. Any inhumane equipment will be scored accordingly.

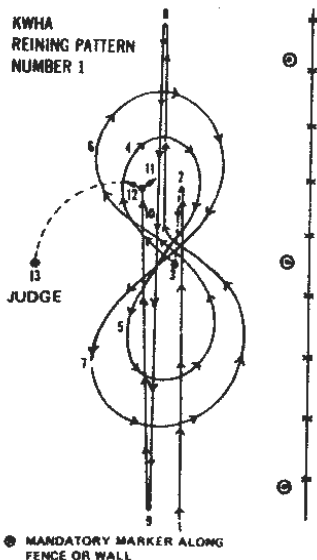

The arena or plot should be approximately 50 x 150 feet in size. The judge shall indicate with markers on arena fence or wall the length of the pattern, markers within the area of the pattern will not be used.

Ride pattern as follows:

1. To 2. Run with speed, past center marker.
2. Stop and back up to center of pattern.
3. Settle horse for approximately 10 sec. Start lope to the right. Figure 8 should be made inside the end markers
4. & 5. Ride small Figure 8 at a slow lope.
6. & 7. Ride a larger Figure 8 at a faster lope.
8. Left roll back over hocks (should be made past far end marker.)
9. Right roll back over hocks (should be made past near end marker.)
10. Stop (should be made past center marker) let horse settle, and in approximate area of stop, do the pivots.
11. Pivot right or left 90 degrees.
12. Pivot opposite direction 180 degrees.
13. Walk to judge and stop for inspection until dismissed.

**KWHA
REINING PATTERN
NUMBER 2**

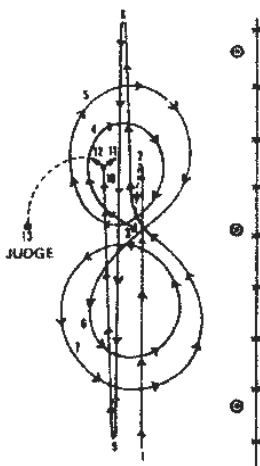

The arena or plot should be approximately 50 x 150 feet in size.

The judge shall indicate with markers on arena fence or wall the length of the pattern markers within the area of the pattern will not be used.

1. To 2. Run with speed, past center marker.
2. Stop and back up to center of pattern.
3. Settle horse for approximately 10 sec. Start lope. Circles should be made inside the end markers.
4. & 5. Ride two circles to the right, first circle small, should be slow, and second circle larger and faster.
6. & 7. Ride two circles to the left, first circle small, and slow, second circle larger and faster.
8. Left roll back over hocks (should be made past far end marker).
9. Right roll back over hocks (should be made past near end marker).
10. Stop (should be made past center marker). Let horse settle, then in approximate area of stop, do the pivots.
11. Pivot right or left 90 degrees.
12. Pivot opposite direction 180 degrees.
13. Walk to judge and stop for inspection until dismissed.

**KWAH
REINING PATTERN
NUMBER 3**

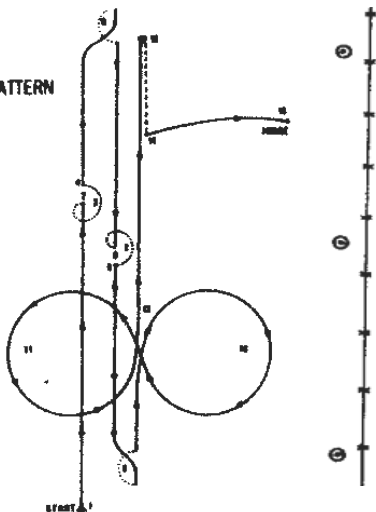

The arena or plot should be approximately 50 x 150 feet in size. The judge shall indicate with markers on arena fence or wall the length of the pattern, but kegs or other markers within the area of the pattern will not be used.

Ride pattern as follows:

1. To 2. Run at full speed (should be run at least 20 feet from any fence or wall).
2. Stop
3. Do a 360-degree spin, to the left.
4. Hesitate
5. Proceed to the area beyond the point indicated by the marker on the arena wall or fence and do a left roll back over the hocks.
6. Stop
7. Do a 360-degree spin, to the right.
8. Hesitate
9. Proceed to the area beyond the point indicated by the other marker on the arena wall or fence and do a right roll back over the hocks.
10. & 11. Ride a figure 8, beginning to the right.
12. & 13. Run at full speed.
13. Stop
13. To 14. Back.
14. To 15. Walk to judge and stop for inspection until dismissed.

**KWHA
REINING PATTERN
NUMBER 4**

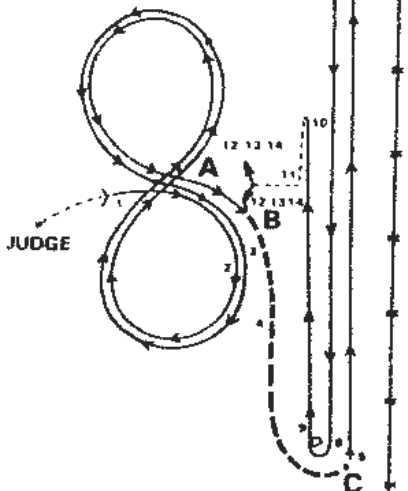

The arena or plot should be approximately 50 x 150 feet in size.

1. Start at judge for inspection
2. Begin work to the right. First figure eight slow.
3. Second figure eight, faster (lead change must take place at point A).
4. Proceed from point B to point C. Can walk or trot.
5. Begin run.
6. Sliding stop.
7. Turn away from the rail, do a spin and a half, no hesitation.
8. Sliding stop.
9. Turn away from the rail, do a spin and a half, no hesitation.
10. Sliding stop.
11. Back over slide marks. Face judge. Walk a few steps.
12. Pivot right or left, no more than 90 degrees.
13. Pivot the opposite direction, no more than 180 degrees.
14. Pivot in direction taken in 12, no more than 180 degrees.

**KWHA
REINING PATTERN
NUMBER 5**

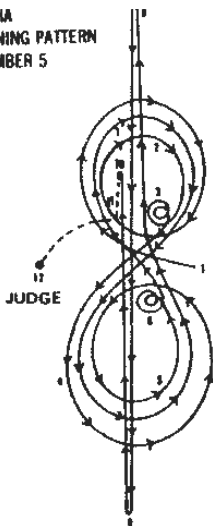

The arena or plot should be approximately 50 x 150 feet in size. The judge shall indicate with markers on arena fence or wall the length of pattern markers within the area of the pattern will not be used.

Ride pattern as follows:

1. Starting in the center of the arena make a large fast circle to the right.
2. Draw the circle down to a small circle until you reach the center of the arena - stop.
3. Do a double spin to the inside of the small circle in the center of the arena - at end of spins horse should be facing the left wall - slight hesitation.
4. Begin on left lead and make a large fast circle.
5. Then a small circle again drawing it down to the center of the arena - stop - no hesitation on these stops.
6. Do a double spin to the inside of the circle - slight hesitation - horse to be facing left wall.
7. Begin on right lead and make a fast figure eight over the large circles - close the eight - and change leads.
8. Run to far end of arena and do a left roll back.
9. Run to opposite end of the arena and do a right roll back.
10. Run back past center of the arena and do a sliding stop. Hesitate.
11. Back over slide tracks.
12. Finish - Walk to judge for inspection and dismissal.

KWHA REINING PATTERN NUMBER 6

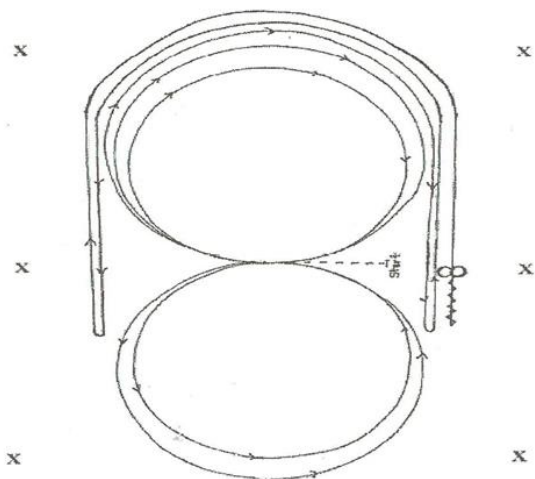

1. Trot to Center of the arena facing the judge. Walk or stop before beginning pattern.
2. Run two circles of similar size to the right-the first slow and the second fast. Change leads in the center of the arena.
3. Run two circles to the left of similar size-the first slow the second fast. Change leads in the center of the arena.
4. Begin a circle to the right. Do not close the circle but run around the end of the arena and down the fence, remaining at least 20 feet from the fence. Run past the center marker, stop and rollback toward the fence.
5. Run back around the end of the arena and down the fence, remaining at least 20 feet from the fence. Run past the marker, stop and rollback toward the fence.
6. Run back around the end of the arena and down the fence past the center marker, stop and back at least 15 feet. Hesitate.
7. Complete 1 spin either direction, hesitate for 5 seconds.
8. Complete 1 spin the opposite direction; hesitate to show completion of the pattern.
9. Walk to judge for inspection.

Section II. Western Pleasure

A. Western Pleasure horses shall be shown at a walk, canter, and trot. They shall be judged on manners, conformation, and suitability for use as Western Pleasure horses.

B. Percentages: Conformation and manners 30%, performance and suitability 70%.

C. Stallions may be shown in this class. Parade equipment shall not be used.

D. Faults: head throwing, tail switching, wide open mouth, rearing, failure to maintain leads and gaits, failure to change leads, halting and hesitating, bleeding mouth or sides, and failure to back if asked to do so by judge.

E. Age groups shall be Women, Senior Women, Men, and Senior Men.

Section III. Junior Horsemanship

A. Western Equipment. Entries in this class shall enter the arena at a walk and ride with the reins in one hand only (two hands may be used if riding a junior horse - see Rules Governing Judged Events). The seat shall be erect and balanced, and the stirrups shall be of such length that the rider can maintain that position in any gait.

B. Rider to be judged on ability to keep horse in designated gait and proper leads and their handling and control of horse. Percentages shall be Horsemanship 70%; conformation and suitability of horse to count 30%.

C. Stallions are barred from this class.

D. The age groups shall be 1 to 9 years inclusive, 10 to 13 years inclusive, and 14 to 17 years inclusive.

E. The Judge has the option of using a pattern for individual work, at the start of the class. The pattern cannot exceed (60) sixty seconds. If a pattern is to be used, the Judge **MUST** post the pattern at least one (1) hour prior to the start of the class.

Section IV. Queen Contest

A. Contestant shall be female, 18 years of age or older, and in Junior Queen Contest the age group will be 17 years and under.

B. Queen Parade mounted and will be judged in the

following manner, for horsemanship 50%, Wardrobe 20 %, Equipment 10%, Appearance of Horse and Rider 20%.

C. Contestant must mount and dismount horse.

D. At the State Show, previous year's Queen not to compete but to act as escort for Queen Candidates.

E. Horse will be ridden at a walk, canter, and trot.

F. Serapes barred.

G. Points accumulated in Junior Queen will count toward the individual year-end award in the Queen Class but will not count toward State or Year End High Point awards. Points accumulated in Senior Queen will count toward individual year end, State and Year End High Point Awards.

Section V. Western Lead Line

A. Rider to be five years of age and under.

B. Horse may be of any size.

C. Horse to be led by an adult, 18 years of age or older, and shown at a walk only.

D. Appearance of leader, rider, and horse to count 50% and horsemanship to count 50%. The lead line class is a junior class and therefore stallions are barred.

E. Parade equipment barred.

F. No child is to be tied on a horse in the lead line class.

Section VI. Bareback Tandem

A. This event shall be listed on the show bill as Bareback Tandem, which would allow contestants of any age to compete.

B. Two contestants mounted on a bareback horse. Western equipment is to be used. Entries in this class shall enter the arena at a walk and ride with reins in one hand only (two hands may be used if riding a junior horse - see Rules Governing Judged Events). Contestants shall not use hands to hold on to each other.

C. Riders to be judged on ability to show horse at walk, trot, and canter; keep proper leads; ease of handling and control of horse; and ability of each rider to keep seat erect and balanced. Percentages shall be horsemanship 70 percent and appearance of horse and riders 30 percent.

D. Contestants will not be asked to mount or dismount horse.

Section VII. Bareback Horsemanship

- A.** Horses shall be shown at a walk, trot, and canter. They shall be judged on manners, conformation, and suitability for use as a bareback horse.
- B.** The rider is to be judged on his ability to keep horse in designated gait and proper leads, and his handling and control of horse. The reins will be held in one hand only (two hands may be used if riding a junior horse - see Rules Governing Judged Events); the seat shall be erect and balanced.
- C.** Percentages shall be horsemanship 70%, conformation and suitability of horse 30%.
- D.** The age group shall be Junior, Women, Senior Women, Men, and Senior Men.
- E.** The judge shall use his own decision on western wear and equipment.

Section VIII. Walk Trot Horsemanship

- A.** Western Equipment: Entries shall enter the arena at a walk. Ride with reins in one hand only (two hands may be used if riding a junior horse – (see Rules Governing Judged Events). Seat shall be erect and balanced. Stirrups shall be of such length that the rider can maintain a balanced seat.
- B.** Rider to be judged on ability to keep horse in designated gait, and overall control at any place in arena. Riders will be asked to walk, trot, and reverse. Riders may be asked to back. Percentages shall be horsemanship 60%, suitability of horse to rider 30%, and overall appearance 10%.
- C.** Stallions are barred from this class.
- D.** The age group shall be 1 to 7 years old. No rider may enter both Walk Trot Horsemanship and Horsemanship 1-9 at the same show.

CHAPTER V - RULES GOVERNING RACES

Section I. General Rules

No contestant shall be disqualified for a rule unless specifically called for in the rule book. No contestant shall be disqualified due to failure or faulty properties.

The following rules apply to all races and running events:

A. In all heat races, horses must be run from a standing start, but all timed events shall have optional standing or moving start.

B. In the Cloverleaf Race, Pair Race, Pair Sack Race, Key Race, Pole Bending Race, Barrel and Stake Race, Western Relay Race, and Devil's Cowhide, a contestant may have a non-assisted running start if desired.

C. In heated events, starting will be done with a flag and the starter will stand on the side of the arena approximately 50 feet in front of the starting line.

D. In all heat races, the starting space shall be between two parallel lines 12 feet apart. Visible chalk lines must be used.

E. There will be sufficient room at the end of the course for turning and stops.

F. In heated races, riders will be disqualified for failure to complete pattern or knocking over a keg or barrel except in the final heat of a race. Riders that disqualify in the final heat shall run again for the remaining placing if necessary. No contestant shall be disqualified because of faulty event properties.

G. A contestant who interferes, in the opinion of the judge, with another contestant during any race or event shall be disqualified.

H. In the event of a tie, riders will be given the option of flipping a coin to determine the winner. If there is a dispute on whether to run or flip, the rider wishing to run will win. In the event of a tie in any timed event, the horse declared the winner in the runoff must run the pattern within two seconds of its original time or the runoff must be held again.

I. Specified race distance may be altered to accommodate small arenas.

J. In timed races, time will start when horse's nose crosses starting line and will stop when nose crosses finish line.

K. Contestants may be assisted into the arena, but no assistance will be permitted to the starting line in any event.

L. All race events are to be 165 feet distance from starting line to end of property or turning line, except for Straight Barrels, Kegs, Pony Express and Stock Horse Race.

M. No contestant will be allowed to wait his or her turn to

ride a racing event inside the arena. All paddock waiting areas must be separated from the arena by permanent fencing.

N. At the State Show, all race events for age group 1-9 shall be timed.

O. There will be a 5 second penalty assessed to the time for each property (e.g.: pole, keg, barrel) knocked over. This excludes the following races: Two Barrel Flag Race, Hay Race, Barrel and Stake Race. No contestant with a (5) second penalty will place higher than another contestant without a (5) second penalty.

P. When running more than one lane in race events that are being timed, there may be a divider line to separate the lanes. This line will start 20 feet before the timer and run down the arena at least 15 feet past the turning line.

Q. Re-Rides

- 1.** A re-ride shall be awarded if a contestant or their horse is interfered with before a disqualification occurs if the interference: 1) possibly affects a contestant's performance; or 2) Causes a contestant's disqualifications. The contestant must decide whether to accept the re-ride before their time may be announced.
- 2.** Anytime a contestant makes a qualified ride and there is a power failure/mechanical failure, operator's mistake or timer interference by another contestant, a contestant will be allowed two (2) chances to make a qualified ride. The announcer may not stop contestant(s) once a race has started since contestant(s) must still qualify before a re-ride will be awarded.

Section II. Events

A. 360 Eight Race

A barrel is centered on the turning line and another barrel is set 75 feet toward the starting line. Contestant is mounted, races to nearest barrel and circles it completely to the left of right then race to the barrel on the turning line (crossing between the barrels as in figure 8 on the way) turning the opposite direction around the second barrel, on return

(crosses between barrels like figure 8) to first barrel and circles it completely the same direction as the first turn and races to finish line. Contestant is disqualified for breaking pattern.

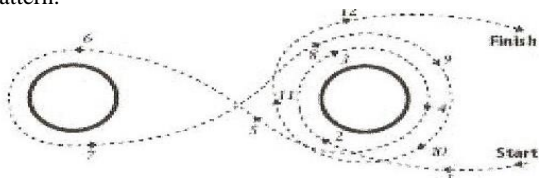

B. Balloon Race

Any number of riders may take part. A blown-up balloon is tied to the belt loop in middle of the waist at the back or pinned there. The object is to break as many of the other rider's balloons as possible without getting your own balloon broken. The rider who ends up with his balloon intact when the rest are broken is declared the winner. Balloons must be broken with hands; no pins are to be used.

C. Barrel & Stake Race

Regulation distance 165 feet. Contestant mounted at starting line 30 feet back of barrel that holds three stakes. At signal, rider starts and picks one stake from first barrel and races to second barrel at turning line, deposits stake and continues until all stakes are placed in second barrel, and races back across starting line. Rider must keep barrels to his right or left at all times. Hitting horse with stake disqualifies rider. Stakes shall be 5 feet long, full round 1 1/8 inches in diameter and of a light nature and 30-gallon barrels painted white to be used. Contestants are disqualified for knocking over a barrel or dropping a stake outside of a barrel.

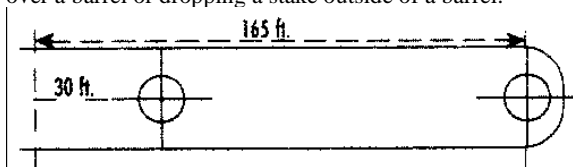

D. Barrel & Stake Graduated

Same rules as Barrel & Stake (above) however only two stakes are used for 1-9.

E. Cloverleaf Race

It is a timed race with only one horse at a time. Three barrels are set up as follows: Two barrels are set 75 feet apart and parallel with the starting line crosswise with the arena, and 40 feet from starting line; the third barrel midway between the first two barrels and 125 feet further down the field. In running this race start at the starting line at a standing or running start, contestant may go to either right or left barrel first but must make two left turns and one right turn, or two right turns and one left turn and back across the starting line.

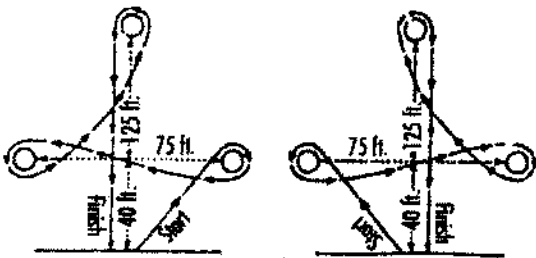

F. Cowhide Race

Regulation distance is 165 feet. Contestant stands with both feet on ground beside horse at starting line. At signal, mounts and races to partner, who stands behind turning line beside cowhide with loose end of 30-foot rope in hand; the other end being tied to cowhide. After handing rope to rider, the horseless man or woman rides on cowhide and is dragged across starting line by rider. (The cowhide drag is to be made with rubber matting 3 feet wide by 6 feet long. Secure a 2x4 3 feet long to one side of the cowhide and secure a loop of rope to both ends of the 2x4. The center of this loop is where a long rope is tied; also, a piece of rope about 18 inches long is tied to the center of the board leaving a loose end for the rider to hold onto). Ropes to pull cowhide with are to be

same kind and length. Time ends when cowhide crosses line.

G. Devil's Cowhide

Timed event. Regulation distance is 165 feet. Mounted contestant pulls other contestant on cowhide across starting line, around barrel at turning line and back across starting line. Hide rider must cross finish line in contact with the cowhide. Team will be disqualified for not making a right turn around barrel, if rope is tied hard and fast to saddle, if rider falls off hide or rope comes loose from horn and falls to ground. Safety helmets are required by hide riders. The cowhide drag is to be made with rubber matting 3 feet wide and 6 feet long. Secure a 2x4, 3 feet long to one side of the cowhide and secure a loop of rope to both ends of the 2x4. The center of this loop is where a long rope is tied; also, a piece of rope about 18 inches long is tied to the center of board leaving a loose end for the rider to hold onto.

H. Figure 8 Stake Race

A pole-bending stake is set on turning line 165 feet from starting line and another pole bending stake is set 60 feet toward the starting line, but in line with the first stake. Contestant is mounted, races to turning line, makes a right or left turn around pole, goes to other pole and makes a turn in opposite direction from first pole then goes back to pole at turning line and makes a turn in same direction as first and races to finish line. Contestant will be disqualified for breaking pattern or touching pole with a hand.

I. Flag Race

Flag race will be over 110-yard course. Flag will be placed in can atop barrel at opposite end. Can holding flag may be knocked down or over. When flag race is timed, time will start when rider crosses start line and rider may turn either right or left at the barrel. Rider will pick flag from holder and time will end when rider crosses finish line with flag. Rider will be disqualified if flag is dropped or flag is used as a whip or bat. When flag race is heated, riders will leave starting space on signal from flag and starter, and barrel must

be turned to the left.

J. Flying W Race

Two pole bending poles are placed on the turning line 30 feet from each fence. Place one pole in the center of the arena 60 feet from the turning line. Rider will run to last pole on either side of arena and make a right or left turn toward center of arena, proceed to center pole make a turn in opposite direction of first turn, continue to pole on opposite side of arena from first pole and make a right or left turn towards fence and on to finish line. Rider will be disqualified for not completing the pattern or touching pole with hand.

K. Half 8 Race

First pole centered on turning line, a second pole is set 6 feet back toward start/finish line. Contestant rides between the poles before crossing turning line, makes a left- or right-hand turn, and races back across finish line. Disqualification if all four feet of horse crosses turning line before going between poles or for touching pole with a hand.

L. Hay Race

Large burlap sacks are filled with hay and placed on the line at opposite end of arena. Rider races from starting line to hay sack, drops rope over hay sack or gets off horse and puts rope around hay sack, then drags hay sack at full length of rope back across starting line. There should be as many sacks as there are contestants and he must use a standard lariat rope at least 20 feet long.

M. Keg Bending Race

Keg Bending will be over a course with six kegs 25 feet apart. The first keg will be 12 feet from starting line. Kegs will be 5-gallon container, from 10 inches to 12 inches in diameter and 13 to 14 inches in height. Time will start when horse crosses starting line. Pass first keg to the right or left, passing each subsequent keg on the opposite side, turning last keg and returning to starting point in the same manner. Rider will be disqualified for failure to complete pattern or

if horse jumps keg. One lane judge is required for each set of kegs. A keg must be jumped by all four feet of the horse to be considered a jump.

N. Key Race

Regulation distance is 165 feet. Two pole bending stakes covered with a 4" by 5-foot red sock are placed on the turning line 5 feet apart. Between the starting line and the turning line there are two pole stakes 10 feet out and 5 feet apart. These poles are covered with a 4" by 5 feet red sock and are in line with the stakes on the turning line. Contestant is mounted at the starting line. At signal races between the stakes across the turning line turns and reverses course back between pole stakes to finish line. Contestant will be disqualified if he fails course by weaving in and out or poles or touches a pole with a hand.

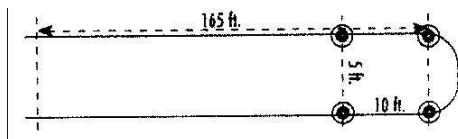

O. Lead Back Race

Course is approximately 110-yards. All contestants line up together at a starting line. Horse and rider must race across given line at other end of arena, dismount and lead horse back. Rider must cross finish line ahead of horse with reins in his hand. Lengths of reins shall not be longer than seven feet. In the lead back race the rider can have a strap or lead rope or rein attached where the riding reins are attached.

P. Musical Chairs

A number of kegs, one less keg than contestants, are set in a circle. Contestants then ride single file around a larger circle to be 80 feet across. When the music stops, rider gets off outside larger circle and leads horse into kegs. He must keep hold of reins and reins shall not be longer than seven feet. A keg is removed each time music stops and one rider is eliminated. When there are only two contestants remaining,

then two kegs are left in the circle, placed close together and the first rider to sit on a keg wins.

Q. Pair Race

Course is approximately 110-yards. Two riders holding hands race to opposite end of arena and back turning left around barrel. Barrel is set approximately 55 yards from starting line. Team will be disqualified for breaking handhold or not staying in own lane.

R. Pair Sack Race

Each entry will consist of two riders and two horses. Each rider holds on to end of burlap sack. They race to the opposite end of the arena, around two 55-gallon barrels and back across the finish line. This is a timed event. Team crosses starting line at a running start. Letting loose of the sack will result in disqualification. Approximately 110-yards course. Barrels should be approximately 30 feet apart or more.

S. Pole Bending Race

Total regulation distance of 165 feet with a distance of 60 feet to be used from the starting line to the first pole. For each contestant competing there shall be a line of six poles (wood or plastic pipe, but all the same), 5 or 6 feet high, 1 inch to 1-1/2 inch in diameter and painted white. Bases shall be of flat nature with no sharp edges, a minimum of 11 inches and not to exceed 15 inches in diameter and uniform in size and shape. Total weight of pole and base shall not exceed 12 pounds. All lanes to have uniform poles set 21 feet apart. The last pole in line shall be placed on the turning line. At start, contestant may start either to the right or to the left of the first pole and then run the remainder of the pattern accordingly (see pattern). Contestant is disqualified for touching pole with a hand and failure to follow the course.

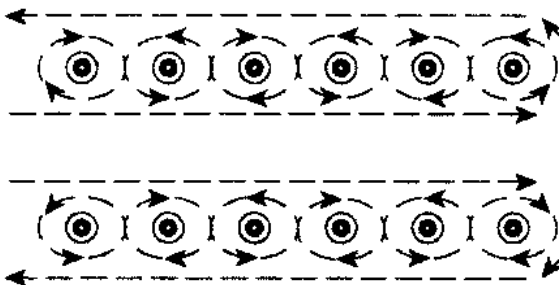

T. Polo Turn

Rider races to pole centered on turning line, makes a complete circle (one and a half revolutions) around pole, then returns back across finish line. Rider may turn to either right or left. Rider will be disqualified for not completing the pattern or touching pole with hand.

U. Pony Express Race

Race shall be over a course inside an arena or on an oval track. If inside an arena, four 55-gallon barrels shall determine the course. Four riders using four horses saddled and bridled stand at the starting line. Timer shall say go and first rider mounts with a baton, rides around the course, dismounts, and gives baton to second rider. Second rider mounts, rides around course, dismounts and gives baton to third rider. Third rider mounts, rides around course, dismounts and gives baton to fourth rider. Fourth rider mounts wearing an armband, rides around course to finish line and stops clock for time. Riders cannot use any physical assistance from another team member. Team is disqualified if baton is dropped or used as bat or whip.

V. Relay Race

Race to be over approximately 110-yard course. Each team consists of four horses and riders. At flag signal first rider with baton in hand races from starting line to opposite end of arena, turns left around barrel and back to starting line. The baton must be handed to another member of team in

back of starting line and so on until race is finished. If baton is dropped the team is disqualified. The baton cannot be used as a bat and in a relay race, the last rider must be must identified by an armband. All batons must be 5/8-inch rubber hose and 15 inches long.

W. Rescue Race

Course is approximately 110-yards. Contestants line up with one person on horseback at starting line and other person behind turning line. At start, rider races to opposite end of course picking up partner, races back over finish line. The contestant being picked up must make contact with partner behind turning line and be astride the horse behind the saddle when crossing the finish line (astride the horse is at least the knee of the rider on the other side of the horses' backbone).

X. Ribbon Race

Riders start from starting line and race to opposite end of the arena to line where ribbons are fastened to ground by nail. Riders must dismount horse to secure ribbon; remount and race back to starting line.

Y. Rock and Roll Race

Team. Regulation distance is 165 feet. Four contestants, one mounted on a bareback horse at starting line. Other three riders are behind the turning line. At signal, rider races across turning line, picks one rider up and races back to starting line. Front rider dismounts. Remaining rider races back to next rider in line picks him up and races back to starting line. Front rider dismounts. Remaining rider races to last rider picks him up and races back across starting line. The last rider shall wear an armband.

Z. Saddling Race

Competitors ride their horses bareback up to saddles, dismount, saddle their horses, mount and race back to finish line.

AA. Saddle and Rescue Race – Pairs

Regulation distance is 165 feet. Rider mounted on bareback horse at starting line. Second person stands behind turning line with saddle blanket in hand. Saddle is on ground behind turning line. At signal the rider races to partner behind turning line. Both saddle horse. The partner on the ground mounts, rider mounts on the back, and they race back across the starting line. Conventional cincha hooks or tack-carriers or any conventional western riding equipment will be permitted. Judge will inspect equipment before and after race. All tongues have to be in a hole of the latigo. Riders will be disqualified for the person on the ground touching the horse before it crosses the turning line.

BB. Speed Barrels

Three (3) barrels with 50 feet between barrels, and the last barrel shall be centered on turning line. Contestant weaves barrels through and back. Contestant may start weave to either left or right of the first barrel.

CC. Stock Horse Race

In the stock horse race the equipment should consist of regulation stock saddle and bridle, curb bit or hackamore with leather covered chain noseband or bridle leather noseband. Shall be run the length of arena or prescribed length on a track if available. It is recommended that the course be 220 yards or 440 yards.

DD. Straight Barrels

Three 55-gallon barrels set in a row may be turned either right or left going down with end barrel turned the same direction as the first two, then turn barrels in the opposite direction on return trip. It shall measure 37 feet from starting line to first barrel and 50 feet between next two barrels.

EE. Trailer Race

Each entry will consist of a team of two contestants and a horse. They pull their trailer into the arena attached to a car

or a pick-up, line up at starting line.

Equipment – Horse must have a halter on (need not be tied to trailer). Saddle, blanket or pad, and bridle (blanket cannot be attached to saddle). At the start of the race the two contestants must be seated in the front seat of car or pickup. When flag is dropped, they jump out, run around and unlatch trailer, back horse out of trailer, take halter off, put on bridle, blanket or pad and saddle (saddle must be cinched). Ride to the opposite end of the arena, around 55-gallon barrel. Then race back to trailer. Take saddle, blanket or pad and bridle off and put halter on. Load horse and all equipment. Both contestants get back into front seat of car or pickup and turn on lights to declare the winners. If you use a car in the trailer race, trunk lid may be up at starting time. If you use a pickup, all equipment must be on the rear floor of the pickup. If your trailer has two latches, one may be loosened before starting time. You must have at least one trailer latch fastened at the beginning and finish of a race. Lead rope must be inside trailer at start and finish of race. Car or pickup doors must be shut before lights come on. Reins must be on both sides of horses’ neck while turning barrel.

FF. Tunnel Race

Use 55-gallon barrels with both ends out. Place barrels on their side at other end of arena. Use same amount of barrels, as there are riders. The contestants race down to designated barrel, dismount, crawl through barrel then remount horse and race back to starting line. Reins shall not be longer than seven feet.

GG. Two Barrel Flag Race

Equipment needed: 2 30-gallon barrels painted white, 2 5-foot poles (1” to 1 ¼ in diameter) with a different 9-inch color flag on the poles. Regulation distance is 165 feet. Contestant races to first barrel 30 feet from starting line, picks up stake with colored flag and races to second barrel on turning line 165 feet from starting line, deposits the stake into barrel and picks up stake with different colored flag and races back to first barrel and deposits that stake into barrel,

keeping to his right or left at all times. Contestant will raise right or left hand when coming into arena to tell the arena crew what side of barrel they will pick up stakes. Approximately 1" to 2" of dirt will be put in bottom of first barrel. Contestant will be disqualified for hitting horse with stake, dropping stake or knocking over barrel. In the event of a broken stake, the portion remaining in the barrel must be the full diameter of the stake to be considered a qualified ride.

HH. Water Carrying Race

Course is approximately 110-yards. Competitors ride to the end of course carrying a cup, where there is a bucket full of water placed on a barrel. They shall fill the cup and ride back to a barrel placed 15 feet from the starting line on which a pint jar is placed, riding back and forth circling each barrel in either direction until the jar is filled to overflowing then crossing the finish line. You do not have to circle the barrel after the jar is filled.

II. Western Relay Race

Race to be run counterclockwise around 4 barrels, per diagram. Barrels 1 & 4 shall be placed two feet from starting line. Barrels 2 & 3 shall be placed on the turning line. All barrels are to be 30 feet from fence. All batons must be 5/8-inch rubber hose and 15 inches long.

Each team consists of four riders and horses. First rider will start between 3rd and 4th barrel, race around arena, passing baton between 3rd and 4th barrel and so on with each rider until race is finished. All batons must be passed behind starting line. The baton may not be used as a bat. The horses waiting to run must be kept in between the 4 barrels until their turn to run. Run is complete when rider crosses finish line and he cannot re-cross timer line for any reason.

Disqualifications: Using baton as a bat, dropping baton, re-crossing timer line after completion of run.

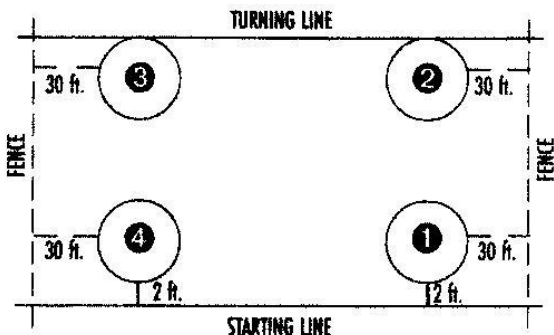

CHAPTER VI – MISCELLANEOUS RULES

Section I. Judges

1. Must have been a member of KWH A Inc., in good standing for the immediate past one year.
2. Must have taken and passed a written examination approved by the Board of Directors.
3. The Board of Directors must approve the individual.
4. Must be 21 years of age at the time of approval by the Board of Directors.
5. Must have done an apprenticeship at (1) show offering all the current KWH A State Show events or (2) shows offering less events but must include at least (1) performance event and (1) heated event with a qualified judge. The shows also must be KWH A sanctioned.
6. The judge serving his or her apprenticeship may ride in his or her respective age group but not in team events where all ages are combined into 1 class.
7. In all judged events must wear cowboy boots, western hat, long sleeved shirt, jeans or pants. In all race events may wear a short-sleeved shirt with collar. Hat is also optional.
8. More than one approved KWH A judge may judge at the same show. (Even if not listed on show bill)
9. Judges may ride in his or her respective age group events and/or team events at a KWH A show they are judging,

provided another qualified KWHHA judge takes over judging said events.

10. Judges may appoint or approve turning line judges, finish line pickers, lane judges, etc. as deemed necessary in any event.

Section II. Judging

The KWHHA Board of Directors may vote to hire a judge to judge the Fall State Show; or they may vote to use a multi-judge system by requesting all approved KWHHA judges to assist at the fall show. This decision shall be made by the board and announced to the membership prior to the first show of the season. Judges are to sign their State Show Forms. The single, two, or three judge system shall be optional with the management in local shows. The KWHHA will have a list of qualified judges for all member clubs. A qualified judge must be used at all member show in order to have a qualified show.

The decision of the judge is final.

In a judging event, the judge shall not place his horse or his family. Family shall be defined as: husband, wife, son, daughter, mother, father, grandfather, grandmother, grandson, granddaughter, brother, sister, nephew, niece, aunt, uncle, and step-family members or in-laws as noted here.

The Judges Committee of the Board of Directors shall have the sole authority of selecting the judge and/or judges for the State Show.

Section III. Protests

Any contestant questioning his announced time in any event must make complaint at the announcement stand before the close of the day's show.

Section IV. Penalties

Any act of discourtesy or disobedience to a judge or to an official of this association, or of a member show, by an owner, an exhibitor, his agent, employee, rider, or close relative of such competitor or exhibitor, shall be just cause to give the Rules Committee the right to disbar same from showing at any member show, for a period of time as they may determine the offense warrants. All member shows

shall be immediately notified of any such action taken by the Rules Committee.

Section V. Point System

The KWAHA State Secretary shall send official horse show entry forms at the beginning of each show season. The entry forms shall be sent either electronically and/or paper copy to all saddle club secretaries. The hosting saddle club secretary will print ample copies to have available for their approved KWAHA show. The entry forms showing the top four individual places shall be mailed or hand delivered to the appointed Points Recorder. This shall be sent from the U.S. Post Office or similar service with “electronic tracking” or hand delivered and receiving a receipt from the Points Recorder within 15 days after the show. A copy of the show bill shall accompany the winning entry forms. The Points Recorder shall have the responsibility of tabulating contestant’s points and the top five winners will be awarded honors at a convention held at the end of the year for that purpose. Points will be awarded to the rider and will be counted from shows held during the show season as established by the Board of Directors. Winners in all classes are given the same points. Each contestant in a team event class will be awarded full points as one unit. Points will be recorded as follows: first place receives 4 points; second place receives 3 points; third place receives 2 points; fourth place receives 1 point. In recording individual Saddle Club points for yearend awards, the club will be awarded points for team events as the total from placing of the contestants. For instance, a four-person team event with contestants winning first place, the Saddle Club would receive 16 total points, etc.

Section VI. Rating

Ratings for Division High Point Awards will be computed in accordance with the following regulations:

A. Properly marked Horse Show entry forms made available by the Club Secretaries shall be the sole basis upon which ratings will be computed, and the score thus derived shall be the final authority in determining the awards in each division. The Awards Committee and the points recorder

will use every care to achieve the accuracy in computing the ratings, but neither the Committee, the Points Recorder nor the Association will be liable for the failure of any Member Show to file the results of this show, nor for errors or omissions in the marking thereof, nor responsible beyond the point of accuracy in computing the proper results of each show.

B. Only points earned at Member Shows conducted under the Standard Rules of the Association will be included in reckoning the ratings. No points will be credited for ribbons won at non-member shows even though such show may be conducted in accordance with the Association rules.

C. Points may be turned in to the Points Recorder for 2 shows, per show season, from each member club.

D. An event must be held in five shows during the year to receive a year-end individual event certificate.

E. Throw out the points won by Junior if through error he/she rides in a Senior event, but the remaining places are to be counted.

F. In totaling up the points at the close of the year and awarding certificates, points will be credited to all individual age groups.

G. Original entry forms turned into the Points Recorder may be disposed of 45 days after the fall banquet. Disposal of entry forms and records must be approved by the Board of Directors.

H. Name of rider and number of points per event and overall total points shall be printed on all High Point Certificates.

I. Completed points records shall be available for review at the fall banquet, following the completion of the year end awards ceremony.

Section VII. Regulations for KWHHA State Shows

A. To compete in the KWHHA State Show, a contestant must have accumulated a total of a minimum of 4 points as a unit of rider, horse, and saddle club from member shows throughout the year for each event entered. These entries will be made on valid KWHHA entry forms and sent along with a check to the Points Recorder by the Saddle Club Secretary.

B. The same horse that has been qualified in member shows must be used in the State Show, unless a Veterinarian's certificate restricting horse from competition is presented to the State Show Committee before or during the show, then another horse may be used.

C. If you have qualified for the KWHHA State Show and you or your horse have been injured and are unable to compete, you may get a refund of your state entries.

NOTES

2022 OFFICERS

PRESIDENT

VICE PRESIDENT

SECRETARY

TREASURER

POINTS RECORDER

2022 BOARD OF DIRECTORS

KWHA DATES TO REMEMBER

KWHA SPRING FLING 2021
FEBRUARY 6
RUSSELL, KS

KWHA SPRING FLING 2022
DATE & LOCATION TBA

KWHA BENEFIT SHOW 2021
JUNE 5 & 6
LOCATION TBA

KWHA BENEFIT SHOW 2022
DATE & LOCATION TBA

KWHA STATE SHOW 2021
SEPTEMBER 4 & 5
WAKEENEY, KS

KWHA STATE SHOW 2022
DATE & LOCATION TBA

ANNUAL MEETING & AWARDS BANQUET 2021
NOVEMBER 6
HILTON GARDEN INN, SALINA, KS

ANNUAL MEETING & AWARDS BANQUET 2022
DATE & LOCATION TBA

